



Proxso
Technologies

info@proxotech.in
+91 9650691065



R10 PRO

The next generation touch screen
state-of-the-art universal printing system



RYNAN[®]
TECHNOLOGIES
PRINTING

PRODUCT

DESCRIPTION

The RYNAN R10 PRO is the next generation universal state-of-the-art printing system from RYNAN TIJ Printers. With a 5" touch screen controller that connects to the PRO printhead (TIJ 2.5 technology), the R10 is capable of high-speed applications and is highly adaptable to your packaging printing needs.



VERSATILE



Easy to use

5" Touch Screen with intuitive WYSIWYG interface



Integration

Sleek & streamlined for easy integration with 3rd party products



Flexible

Variable database function to meet the requirements in all kinds of applications

ADAPTABLE



High Quality

Max. 600dpi print quality



High Speed

76m/min @ 300x300 dpi



Head Printing

Connect to a single printhead

WHY CHOOSE

R10 PRO



SIMPLE, INTUITIVE OPERATION

- ✓ User friendly 5" touchscreen color display with WYSIWYG graphical interface
- ✓ Easy to setup and integrate with any production line/ devices (PLC, Camera, Check-weigher, etc)
- ✓ Built-In Internal Sensors
- ✓ Single printhead support



EXCELLENT PRINT QUALITY & CAPABILITIES

- ✓ High quality 600 dpi max print resolution
- ✓ High speed print at 76m/min at 300dpi
- ✓ Print height of up to 1 inch (25.4mm)
- ✓ Print length of up to 1.5m



TIJ 2.5

- ✓ Wide Selection of Aqueous, Solvents & UV inks available
- ✓ Minimal downtime, ink cartridges can be replaced easily
- ✓ No long start/shutdown procedure to follow
- ✓ Minimal printhead cleaning, filter replacements or any maintenance requirements

SPECIFICATIONS

TECHNICAL SPECIFICATIONS

Printing Technology	HP TIJ 2.5
Controller Dimensions	155 x 107 x 40 mm
Printhead Dimensions	216.4 x 49.1 x 65 mm
Controller Weight	622g
Print Head Weight	412.4g
Display	5" LCD Touch Screen
Power Supply	AC 100V–240V, 50/60Hz, DC 24V 2.5A
Resolutions	Max 600 DPI
Print Speed	76m/min @ 300x300 dpi
Density	3 levels
Throw Distance	5mm

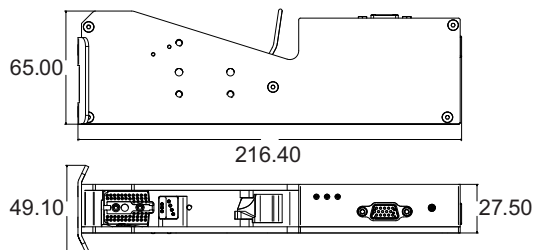
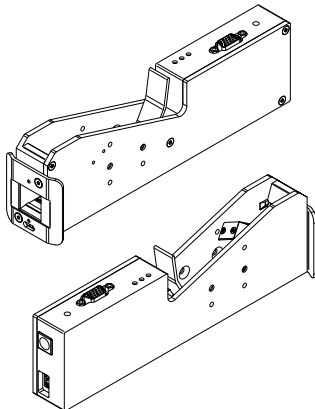
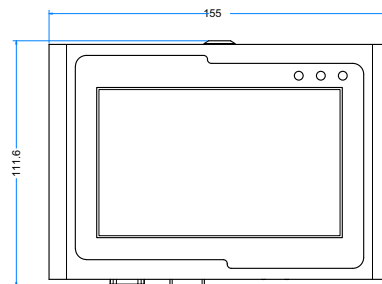
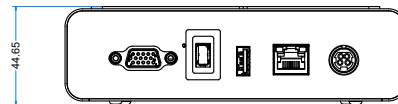
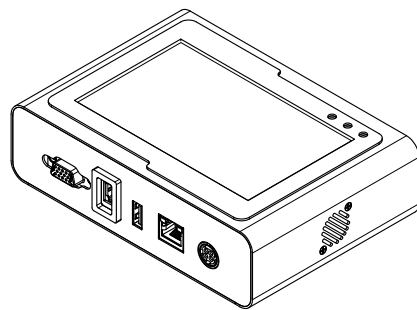

FEATURES

Wide Range Of Print Types	<ul style="list-style-type: none"> • Text, Counter • Box/Lot • Datetime • Expiry Date • Julian Date • Shiftcode • Image • Database <p>1D & 2D Barcodes (Code 11, Code 39, Code 128, EAN, QR, Datamatrix, GS1 Datamatrix...)</p>
Printable Height	Maximum 25.4mm
External Connections	<ul style="list-style-type: none"> • Build in sensor • External Sensor • Encoder and Alarm beacon
Template Length	1.5m
Database	TXT, CSV, SQL, MySQL, SQLite, JSON
Advance Features	<ul style="list-style-type: none"> • Free design in template up to 1 inch (1 head) • POD (Print online data) Integrate with other devices (PLC, Camera, Checkweigher...) via RJ45 • Real-time Printing • WYSIWYG (what you see is what you get) • Data upload, Backup & Recovery via USB
Printable Characters	Windows true fonts - Free design in template up to 1 inch (1 heads)
Print Languages	English (default), Vietnamese, Chinese (PRC), Turkish, Korean, Russian, Japanese, Hebrew, Spanish, Thai, Portuguese and Arabic...
System Languages	English (default), German, Vietnamese, Chinese, Korean, Russian, Turkish, Portuguese, Spanish, Polish, Greek and Italian (and others)



APPLICATIONS

INDUSTRY OPPORTUNITIES

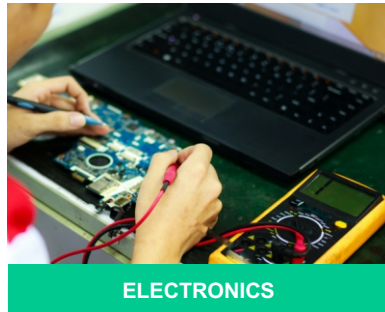
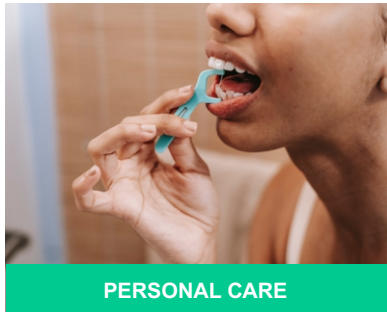

TYPES OF PRINTING APPLICATIONS

POROUS



NON - POROUS



ABOUT

RYNAN TECHNOLOGY

RYNAN Printing is one of the business entities of RYNAN Technologies. Founded in 2015, the company is based in Vietnam, Singapore and India. RYNAN creates and develops industrial thermal inkjet technology and has been paving the way for the industry since. Serving a global community of customers in multiple sectors including industrial coding and marking, packaging, and pharmaceuticals.

OUR VISION

RYNAN is devoted to creating the most effective and environmentally conscious solutions for the market. Helping partners and customers achieve their business targets, by supplying reliable and cost-effective products.



RYNAN TECHNOLOGIES © 2022

The information presented in this brochure, to the best of our knowledge, is accurate at the time of publication, and is presented as general information and no representation or warranty is expressly or impliedly given as to its accuracy, completeness or correctness. RYNAN Technologies reserves the right to make changes to this brochure and the contents herein, including without limitation, functionality, features, specifications, images, benefits, design, components, performance, and any other product information.



RYNAN[®]
TECHNOLOGIES
PRINTING

www.rynanprinting.com

Authorised RYNAN Partner



Proxso
Technologies

B-78, HIND VIHAR, PREMNAGAR 3rd
KIRARI SULEMAN NAGAR
NEW DELHI-110086
Email.: info@proxsotech.in
Mob. : +91 9650691065
Website: www.proxotech.in